

# Medley<sup>®</sup> Ergo Family



For a myriad of client needs!



Yes, you can.®

The **Medley Ergo** range from Invacare offers the perfect balance of economy, functionality and quality. The optimised length of the various mattress platform sections provides increased comfort for clients when sitting up in bed, it also reduces shear and friction when the bed sections are being adjusted and prevents clients sliding downwards. The *Invacare Medley Ergo Low* offers the same benefits as **Medley Ergo**, but boasts extra-low height levels, thus maximising safety for individuals liable to fall out of bed. Both the **Medley Ergo** and **Medley Ergo Low** can be transformed into the *Invacare Medley Ergo Select*. **Medley Ergo Select** is a particularly stylish model in natural beech, creating a homely feel suited to any environment.

## Reduced shear and friction

The different sections of the mattress platform boast optimal dimensions designed in accordance with anthropometric statistics and pressure mapping recommendations:

- ▶ Increased comfort when sitting
- ▶ Reduced shear and friction
- ▶ Minimised risk of slipping downwards during profiling
- ▶ Optimised for shorter, unstable patients



## Height is no longer an issue

The flexible design of the **Medley Ergo** Family allows the bed to be mounted at an extra low height, or a higher position if preferred, creating a range of working levels for the carer and transfer heights for the patient. This is facilitated by the unique design of the bed end, which enables the mattress support to be mounted in both upper and lower positions. All side rails comply with the new standard, IEC 60601-2-52.

## More work done in less time

The *Invacare Medley Ergo* Family has been specially designed for timely transportation in the transient working environments of nursing homes and medical centres. As an option, it comes equipped with a special transport fitting so that the bed can easily be collapsed, moved and re-installed in a variety of locations. In addition, any assembling can be done without the use of tools or technicians, saving you time, money and effort.



# 7

## EXCLUSIVE FEATURES

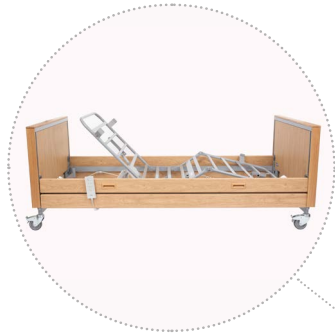

1

### Homely design

- ▶ Now available in beech and oak. The **Medley Ergo Select** offers a more attractive, homely design for **Medley Ergo** and **Medley Ergo Low**. Also available as a retro-fit, this aesthetic bed end cover fits with precision onto the bed actuators and can be removed at any time.
- ▶ The **Medley Ergo Select** comes in an attractive, homely design. The leg supports are equipped with Rastofix to enable individual positioning of each support. **Medley Ergo Select** can easily be dismantled and stored, using a transport fitting for moving and storage.



2

### Medley Ergo Low

- ▶ The ability to position the bed at a lower level means increased security for users and real peace of mind when going to sleep. When necessary, caregivers can raise the bed to a more suitable, above-ground height.
- ▶ The **Medley Ergo Low** makes it easier for individuals to get in and out of bed, equating to greater independence for users.
- ▶ The **Medley Ergo Low** offers a range of adjustable heights, from 21 - 61 cm and 28 - 68 cm.

3

### Optimised dimensions of mattress platform

- ▶ According to expert recommendations for anthropometrical measurements and pressure mapping requirements to reduce shear and friction and increase client comfort.

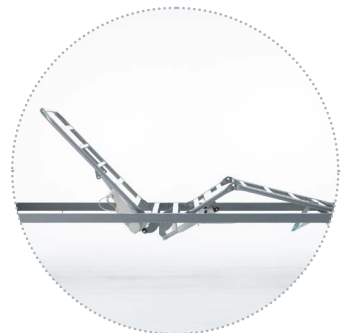



4

### Shipping and Storage

► **Medley Ergo** beds are very easy to store and transport when placed on the dedicated transporter.



5

### Select design for *Medley Ergo*

► The homely design of **Medley Ergo Select** can also be retro-fitted.

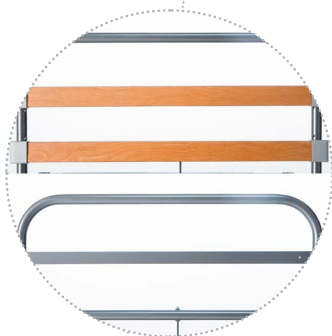

6

### Mattress support

► Choose from steel or wooden slats.



7

### Double height positions for bed ends

► Adjustable height ranges for **Medley Ergo** of 33 – 73 cm or 40 – 80 cm.  
 ► **Medley Ergo Low** 22 – 62 cm or 29 – 69 cm.

## Key features and benefits



### ◀ Easy to attach side rails

Full-length side rail in wood or steel. Easy to mount without the use of tools.

Available in extended version as well.



### ◀ Side rails

A range of collapsible steel side rails:

- Scala 2 range in various heights.

### Available accessories:

- ▶ Lifting Pole: Light and easily adjustable.
- ▶ Mattress support extension: Extension kit for increasing mattress support length by 15 cm.
- ▶ Hand controls: With or without lockable functions.
- ▶ Transport fitting: For easy storage and transport.

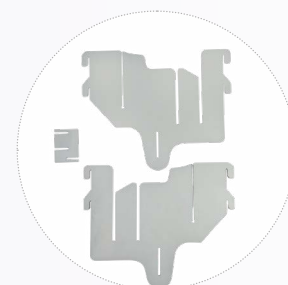

## Technical data ▼

For more comprehensive pre-sales information about this product, including the product's user manual, please see your local Invacare website.



Width outside  
Width inside ▼

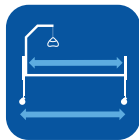

Length outside  
Length inside ▼

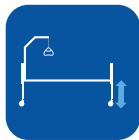

Height adjust-  
ment ▼

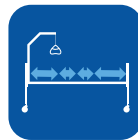

Mattress support  
dimensions ▼

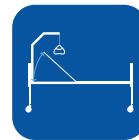

Backrest angle ▼

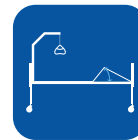

Thigh angle ▼

<b>Medley Ergo</b>	1020 mm 900 mm	2240 mm 2080 mm	400 - 800 mm or 330 - 730 mm	800 - 230 - 300 - 670 mm	0 - 70°	0 - 24°
<b>Medley Ergo Low</b>	1020 mm 900 mm	2240 mm 2080 mm	280 - 680 mm or 210 - 610 mm	800 - 230 - 300 - 670 mm	0 - 70°	0 - 24°



Legrest lift ▼

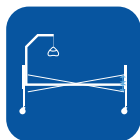

Tilt option<sup>1</sup> ▼



Total weight ▼



Max. user weight ▼



Heaviest part of the  
product ▼

<b>Medley Ergo</b>	0 - 11°	11°	64 kg	SWL 180 kg 145 kg	17 kg
<b>Medley Ergo Low</b>	0 - 11°	11°	64 kg	SWL 180 kg 145 kg	17 kg

Complies to the safety standard, IEC 60601-2-52

1. Please notice that the tilt function is only practised for users under medical supervision.

## Frame colour ▼

**NB:** The bed must not be used by patients under 12 years of age, or by patients with body size equivalent to an average 12 year old or smaller.

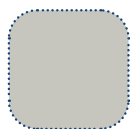

Silver



Beech



Oak

Please notice colors may vary slightly from those displayed above.

**Tel: +41 61 487 70 70**  
hqeurope@invacare.com  
www.invacare.eu.com

Invacare International GmbH  
Benkenstrasse 260  
4108 Witterswil  
Switzerland



© 2021 Invacare International GmbH. All rights reserved. All information quoted is believed to be correct at time of print.

Invacare reserves the right to alter product specifications without prior consultation. Medley Ergo - EU - 06/2021

**Yes, you can.®**